



# GALILEOS



CAD/CAM SYSTEMS | INSTRUMENTS | HYGIENE SYSTEMS | TREATMENT CENTERS | **IMAGING SYSTEMS**

**WELCOME TO THE NEW DIMENSION OF DIAGNOSTIC IMAGING**

**“Imagine the possibilities” with Sirona 3D.**

The Dental Company

**sirona.**

A big step into diagnostics in the 3rd dimension –  
with superior X-ray technology from Sirona

# GALILEOS

“The GALILEOS system adds 3D imaging to the clinical routines in all dental specialty areas. The sophisticated design of hardware and software allows us to reach our most important goal day after day: satisfied patients.”

Prof. Joachim E. Zöller, University of Cologne, Germany



Dental X-ray diagnostics are moving into the 3rd dimension at a high rate of speed. The enhanced demand for digital diagnostics primarily comes from implantology, oral and maxillofacial surgery as well as orthodontics. GALILEOS from Sirona, adds new diagnostic possibilities creating greater potential for your practice.

## GALILEOS expands the world of dentistry in the 3rd dimension

The introduction of a new dimension requires convincing perspectives in diagnostics, patient information, therapy, and prevention. What can dentists expect from three-dimensional imaging? The GALILEOS solution from Sirona offers far more than just another diagnostic tool ...

- **An X-ray device** that allows for imaging and display of the entire oral-maxillofacial region in one 3D volume. Consequently, the treatment can be assessed and planned in one step.
- **A diagnostic 3D volume** that goes far beyond any two-dimensional images and allows for precise assessment of the teeth, bone structure and anatomical features in their exact spatial dimensions<sup>1</sup>.
- **Software** that presents images in a panoramic format which is familiar to dentists and uses it as the basis for exploring the three-dimensional volume with completely new diagnostic flexibility.
- **A consistent concept** that expands the benefits of 3D images far beyond diagnostics to therapeutic planning and the associated benefits.
- **A perfected technological solution** that integrates quickly and easily into any dental practice thanks to its compact and efficient design.
- **A superior imaging technology that is clinically proven.**

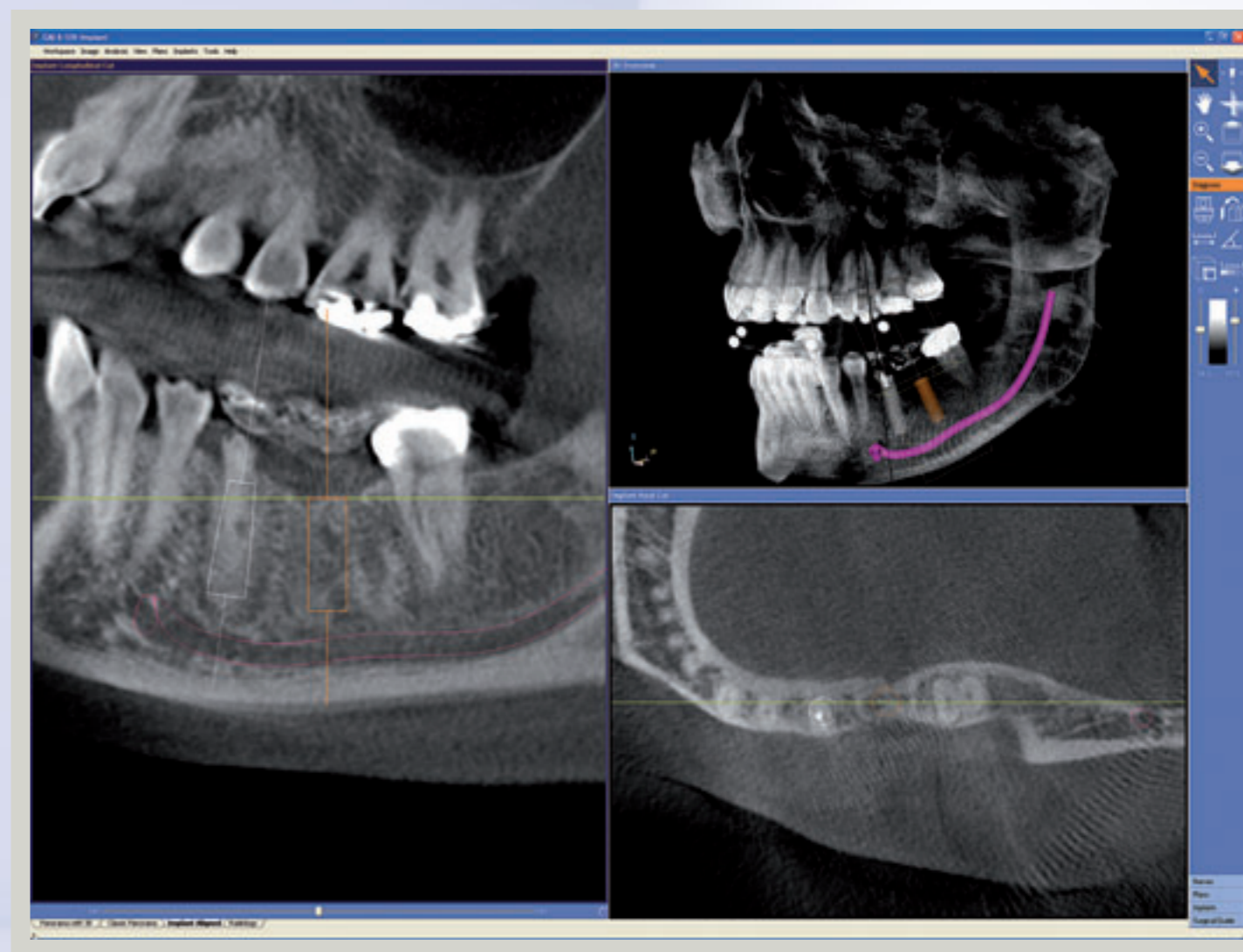

The GALILEOS 3D volume is used to display the mandibular canal in the GALAXIS diagnostic software, implant planning occurs in GALILEOS Implant.

*ConeBeam X-ray images are taken quickly and safely with the patient in a standing or seated position in just 14 seconds.*

1. Neugebauer J., Shirani R., Mischkowski R., Ritter L., Keeve E., Zoeller J., "Comparison of 2 and 3-Dimensional Imaging for the Diagnosis of the Alveolar Nerve Position for the Osteotomy of Third Molar" Proceedings of Computer Assisted Radiology and Surgery CARS'06, Osaka, June 28 – July 1, 2006 Int J CARS 2006;1 Suppl. 1: 535.

## One scan for everything

A single low-dose 3D scan provides the practitioner with the ability to do a comprehensive diagnosis of the entire oral-maxillofacial region: GALILEOS combines the data of 200 individual exposures taken in 14 seconds to create a 3D volume with the dimensions (15x15x15) cm<sup>3</sup> at a high level of detail. The technology also allows for small region, close up views at double the detail without an additional scan.

### 3D X-ray images

Patient positioning using a bite block, forehead support and laser light localizer guided by the center sagittal line, is sufficient to generate a reliable image that is easy to explore and comprehend<sup>2</sup>.

### 3D ConeBeam technology

The GALILEOS detector receives cone-shaped X-ray pulses, which result in 200 individual exposures from a 14-second cycle. The multi-pulse, cone-shaped beam reduces the patient exposure time to 2 to 6 seconds.

### GALILEOS 3D volume

The large dental volume of one billion voxels, ranges from the bridge of the nose to the tip of the chin and the mandibular joints. It projects the bone structures and the soft tissue.



GALILEOS ConeBeam technology – from initial image acquisition to 3D volume display



2. Mischkowski R., Ritter L., Neugebauer J., Dreiseidler T., Zuendorf G., Keeve E., Zoeller J., "Experimental and Clinical Evaluation of a Newly Developed Cone Beam Device for Maxillofacial Imaging" Proceedings of Computer Assisted Radiology and Surgery CARS'06, Osaka, June 28 – July 1, 2006 Int J CARS 2006 1 Suppl 1 523

## Easy and superior diagnostics

After a short reconstruction time, GALILEOS displays far more than just 3D views in high quality images. The system offers a large volume for every display type – 3D, panorama, CEPH, cross sectional (TSA) slices, high-resolution details, presented with intuitive diagnostic navigation in real time.

### Visualization with GALAXIS

The GALILEOS software, a new development integrated in SIDEXIS XG, opens new technologically advanced options to the diagnosing dentist with GALAXIS 3D visualization.

### Diagnostic reliability in 3D

The GALILEOS 3D volume can be easily navigated and diagnosed in the familiar PAN and CEPH display with the help of an intuitive examination window.

### Diagnostic dimension

The simultaneous display of PAN, CEPH and TSA slices as well as radiological slices opens up completely new options for dental diagnostics and treatment<sup>3</sup>.

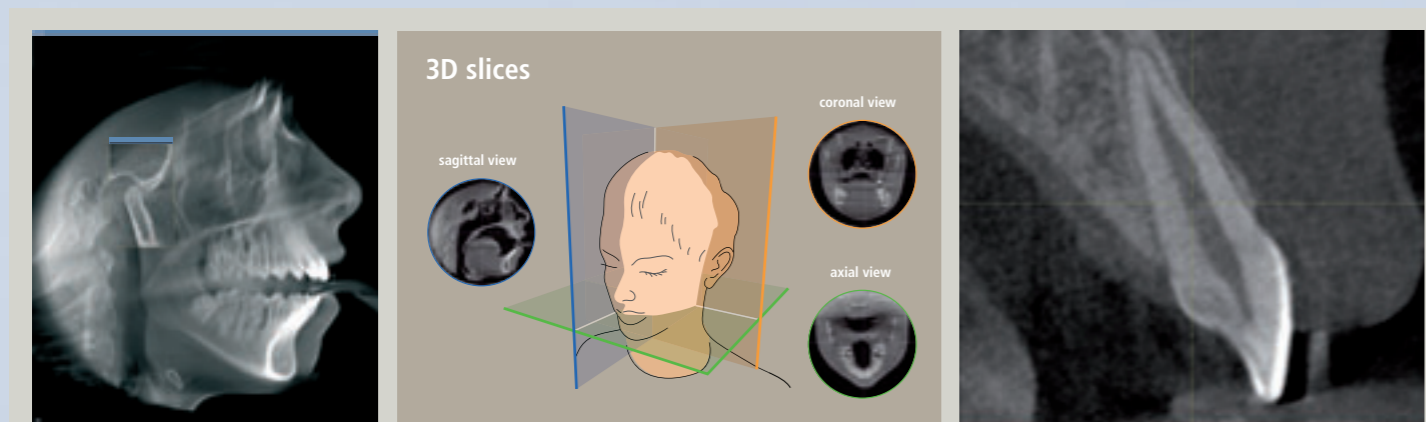

Any slice of the entire 3D volume can be reconstructed with  $0.3 \text{ mm}^3$  voxels, the 3D variant of pixels and can be viewed from any angle. If necessary, selected partial volumes can also be subsequently reconstructed in a higher-detail close-up image with a voxel size of  $0.15 \text{ mm}^3$ .

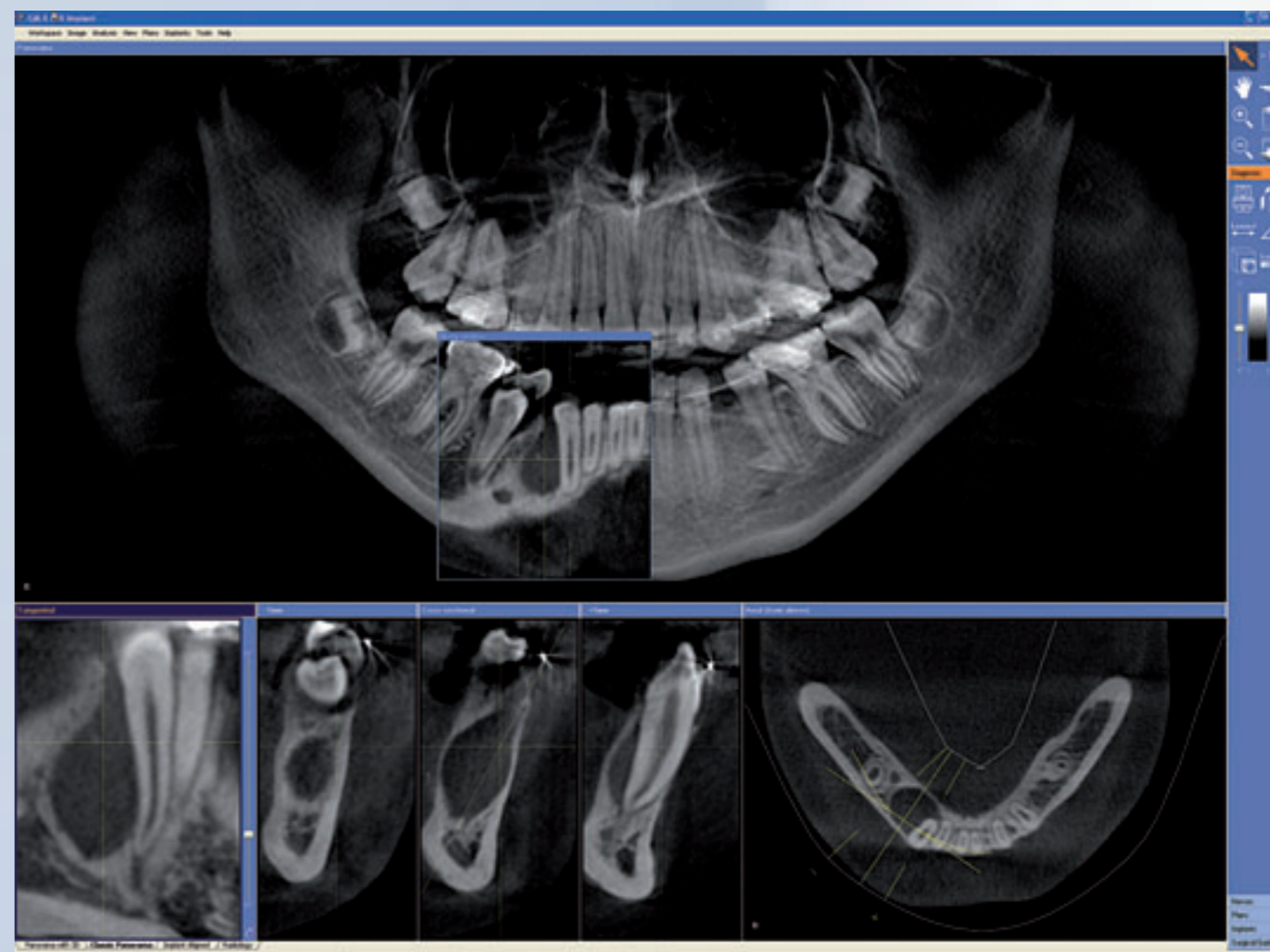

Follicular cyst in region 44 caused by delayed exfoliation<sup>4</sup>

3. Haak R., Wicht M.J., Ritter L., Kusakis P., Noack M.J., "Cone beam tomography for the detection of approximal carious cavitations" Proceedings of the the 53st ORCA Congress, Glasgow, UK, July 5 to 8, 2006.

4. Scheer M., Neugebauer J., Mischkowski RA., Heuser N., Ritter L., Keeve E., Zöller JE., "Evaluation of cystic jaw lesions with 3D Panoramic radiography" Dental Radiology, submitted

## Intuitive navigation in GALAXIS with the "examination window" in the PAN view

Based on the familiar panoramic image format, the program starts a real-time, three-dimensional journey through any area using the patented examination window.

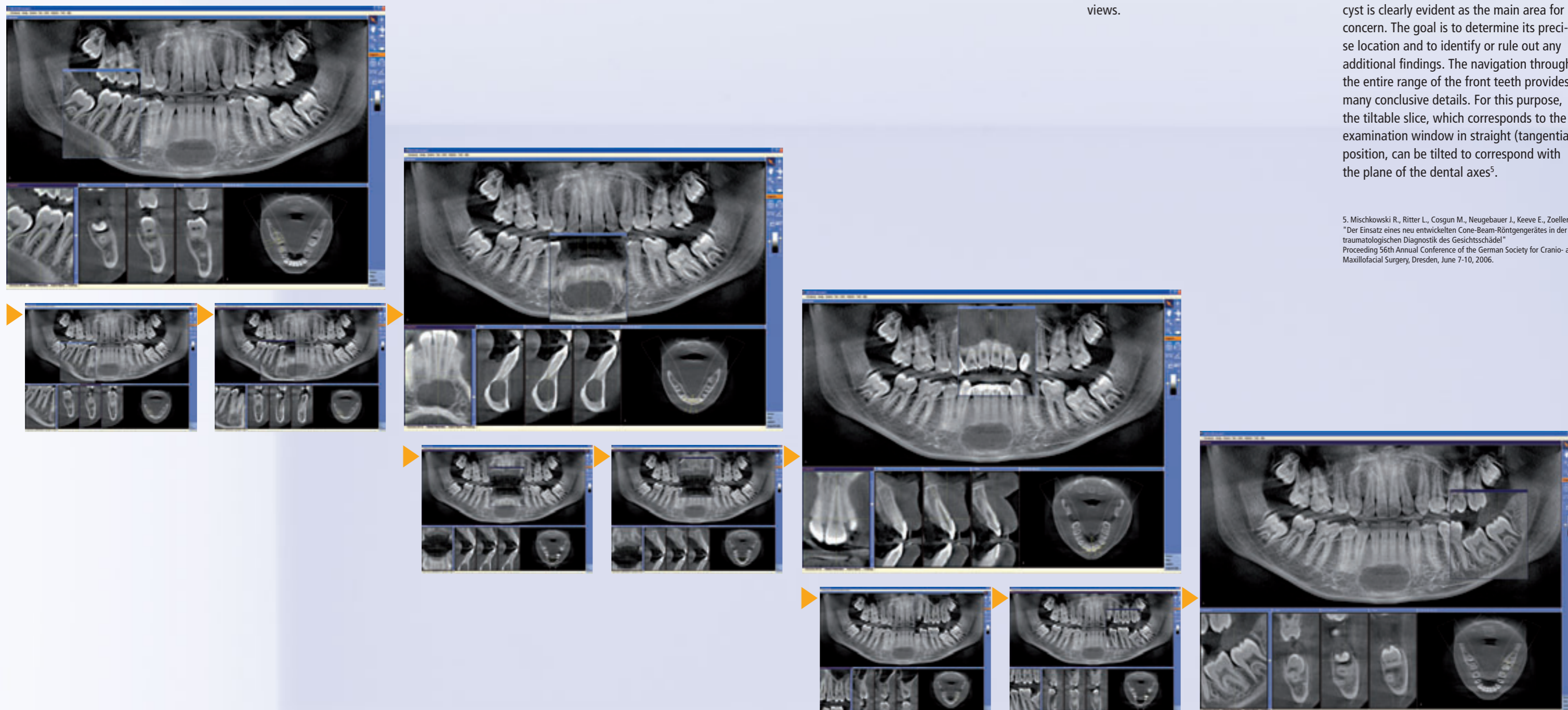

### Traumatic bone cyst at the front of the lower jaw

Dentists can intuitively diagnose the individual 0.3 mm slices of the volumetric image with the assistance of the examination window. The corresponding orthogonal sections are shown in a display that resembles TSA views.

The overview of the detailed slices starts in the right mandible in the molar area. Every area can be clearly displayed by moving the examination window (click and drag the top blue bar) or navigating through the slices (hold the left button down and move the mouse forward or back). The bone cyst is clearly evident as the main area for concern. The goal is to determine its precise location and to identify or rule out any additional findings. The navigation through the entire range of the front teeth provides many conclusive details. For this purpose, the tiltable slice, which corresponds to the examination window in straight (tangential) position, can be tilted to correspond with the plane of the dental axes<sup>5</sup>.

5. Mischkowski R., Ritter L., Cosgun M., Neugebauer J., Keeve E., Zoeller J., "Der Einsatz eines neu entwickelten Cone-Beam-Röntgengerätes in der traumatologischen Diagnostik des Gesichtsschädel" Proceeding 56th Annual Conference of the German Society for Cranio- and Maxillofacial Surgery, Dresden, June 7-10, 2006.

Integrated GALILEOS workflow, ranging from image acquisition and diagnostics to planning and implementation

GALILEOS 

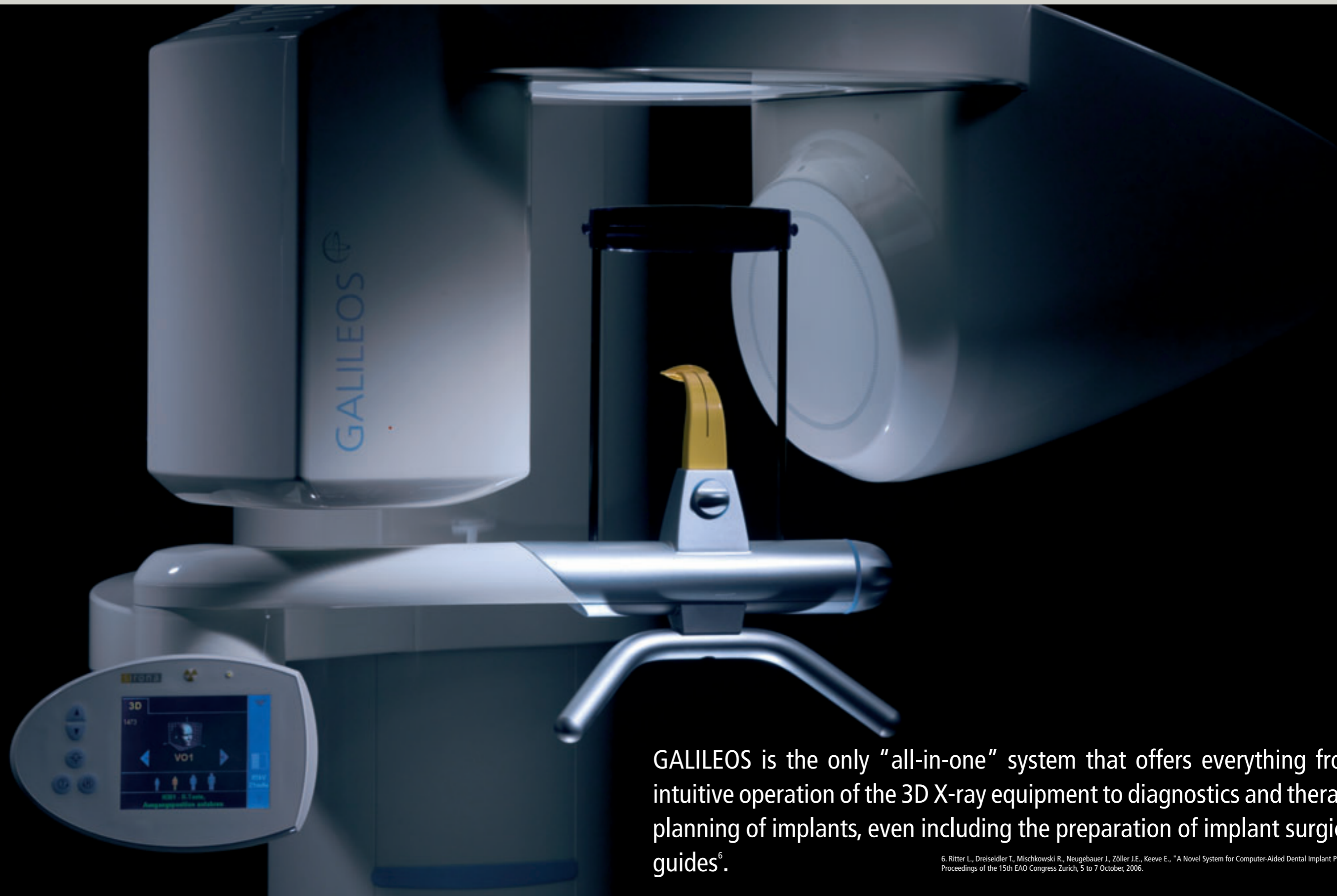

GALILEOS is the only “all-in-one” system that offers everything from intuitive operation of the 3D X-ray equipment to diagnostics and therapy planning of implants, even including the preparation of implant surgical guides<sup>6</sup>.

6. Ritter L., Dreiseidler T., Mischkowski R., Neugebauer J., Zöllner J.E., Keeve E., "A Novel System for Computer-Aided Dental Implant Planning" Proceedings of the 15th EAO Congress Zurich, 5 to 7 October, 2006.

## Clear 3D operational concept for efficient procedures with high diagnostic reliability

As the first comprehensive 3D solution, GALILEOS combines X-ray imaging, visualization, diagnosis, planning and treatment into a single integrated and time-saving process.

**3D imaging right in the dental practice**  
GALILEOS creates a tighter patient relationship with the dental practice. It is no longer necessary to refer implant patients elsewhere for 3D imaging. Additionally, the image volume is much more closely aligned with the special requirements of dentistry and oral maxillofacial treatment.

**Intuitive analysis**  
The GALAXIS 3D visualization in GALILEOS offers reliable dental analysis and assessment. Based on a panoramic view, the diagnosis uses detailed selections of radiological and transversal slices with the aid of diagnostic tools and measuring functions.

**Software-aided planning**  
The integration of implant planning in GALILEOS Implant replaces conventional procedures, both tracing on film and planning in external systems, which require time-consuming data exports and conversions. Instead, GALILEOS Implant offers a direct approach and a more streamlined solution<sup>7</sup>.

7. Neugebauer J., Ritter L., Mischkowski R., Keeve E., Zoeller J., "Dreidimensionale Diagnostik und Umsetzung in der Implantatprothetik" Proceedings 3<sup>rd</sup> Annual Conference of the German Society for Oral Implantology, Baden Baden, Oct. 5-7th, 2006.

### GALAXIS

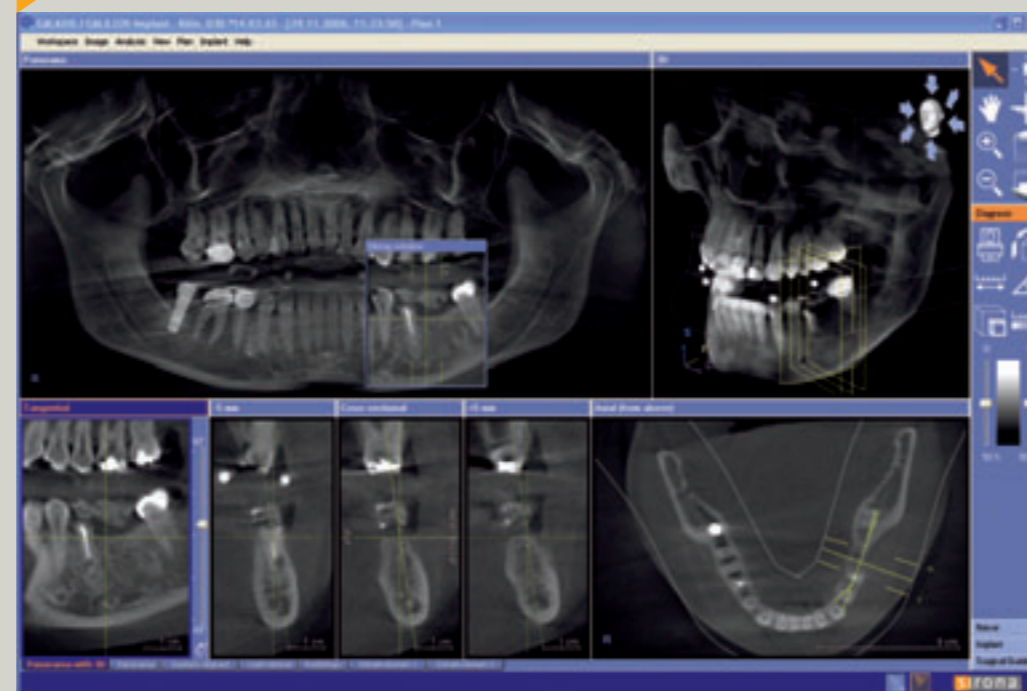

Improved diagnostic certainty using the 3D visualization software GALAXIS: the program is integrated into the intuitive structure of SIDEXIS XG as a plug-in and starts with a simple mouse click.

### GALILEOS Implant

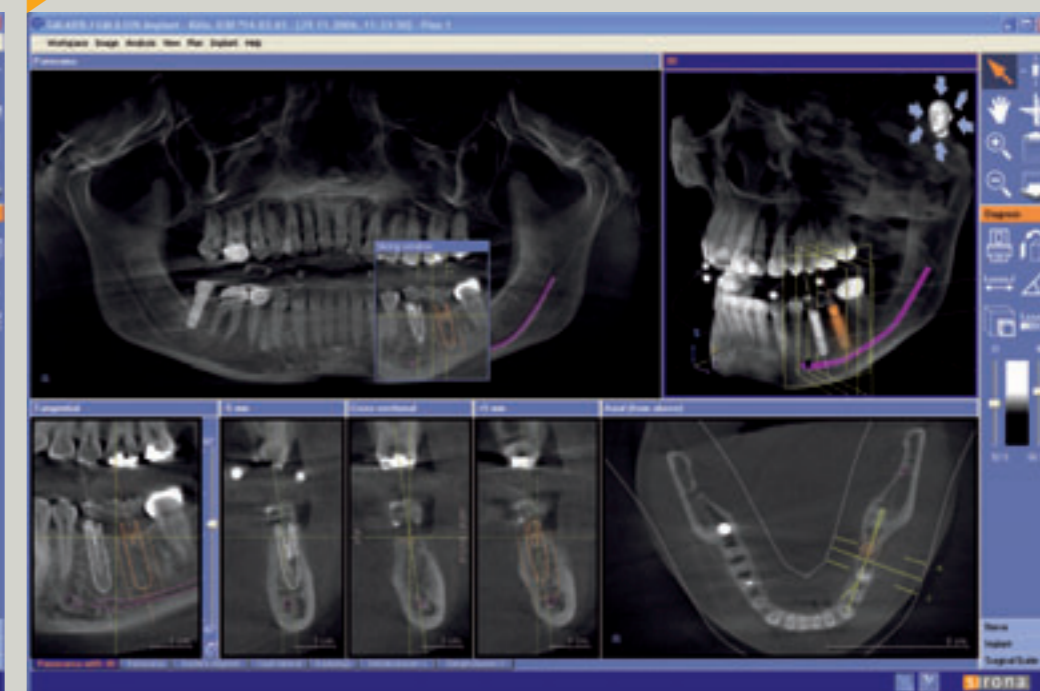

Reliable planning with integrated GALILEOS Implant software: Switch from diagnostics to planning with a single mouse click. The system offers exact measurements based on geometrically accurate displays, marking of anatomically critical structures such as the mandibular canal, retrieval of suitable implants from the database, and virtual positioning in the image of the alveolus.

Ease of operation is improved with the GALILEOS Easypad touchscreen 3D: Intuitive control and operator assistance is driven by icons and interactive messages.





For Sirona, 3D is more than just diagnostics – it is a developmental milestone in the improving relationship between dentists and patients

The added diagnostic value of GALILEOS 3D images is essential. As an innovator in trend-setting technologies of the future, Sirona accompanies dentistry with computer-aided dental surgery (CADs).

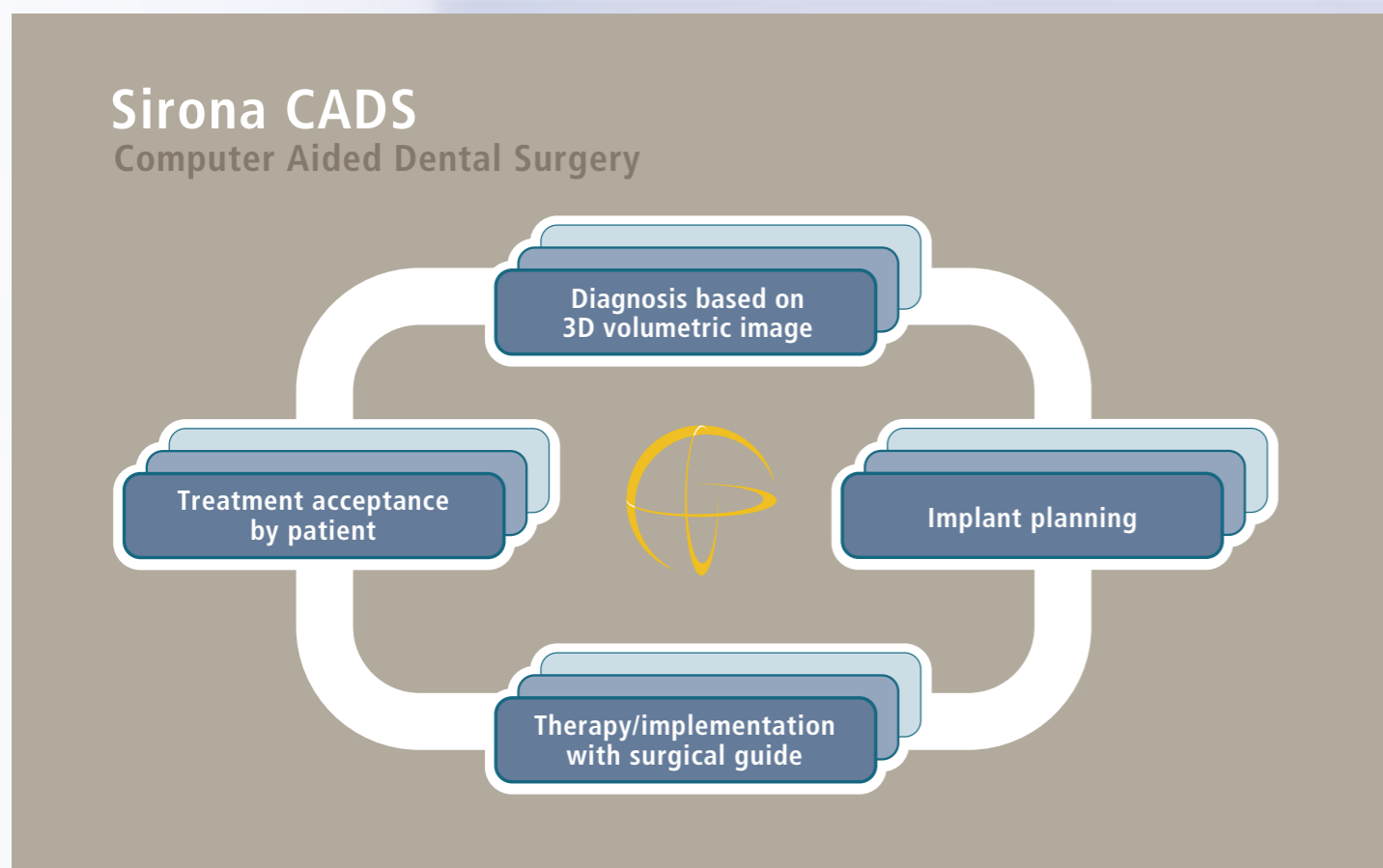

**Holistic patient view**

3D imaging with GALILEOS is not just beneficial for computer diagnostics, but makes an essential contribution to a new world of therapeutic planning, resulting in more complete patient involvement from the initial planning to implementing the appropriate dental solution.

**Confidence and efficiency**

Practitioners can plan efficiently and document surgical procedures with reduced uncertainty, providing understandable patient information, and clearly communicating the situation to their colleagues. This creates a stronger foundation of trust between patient and the dental treatment team.

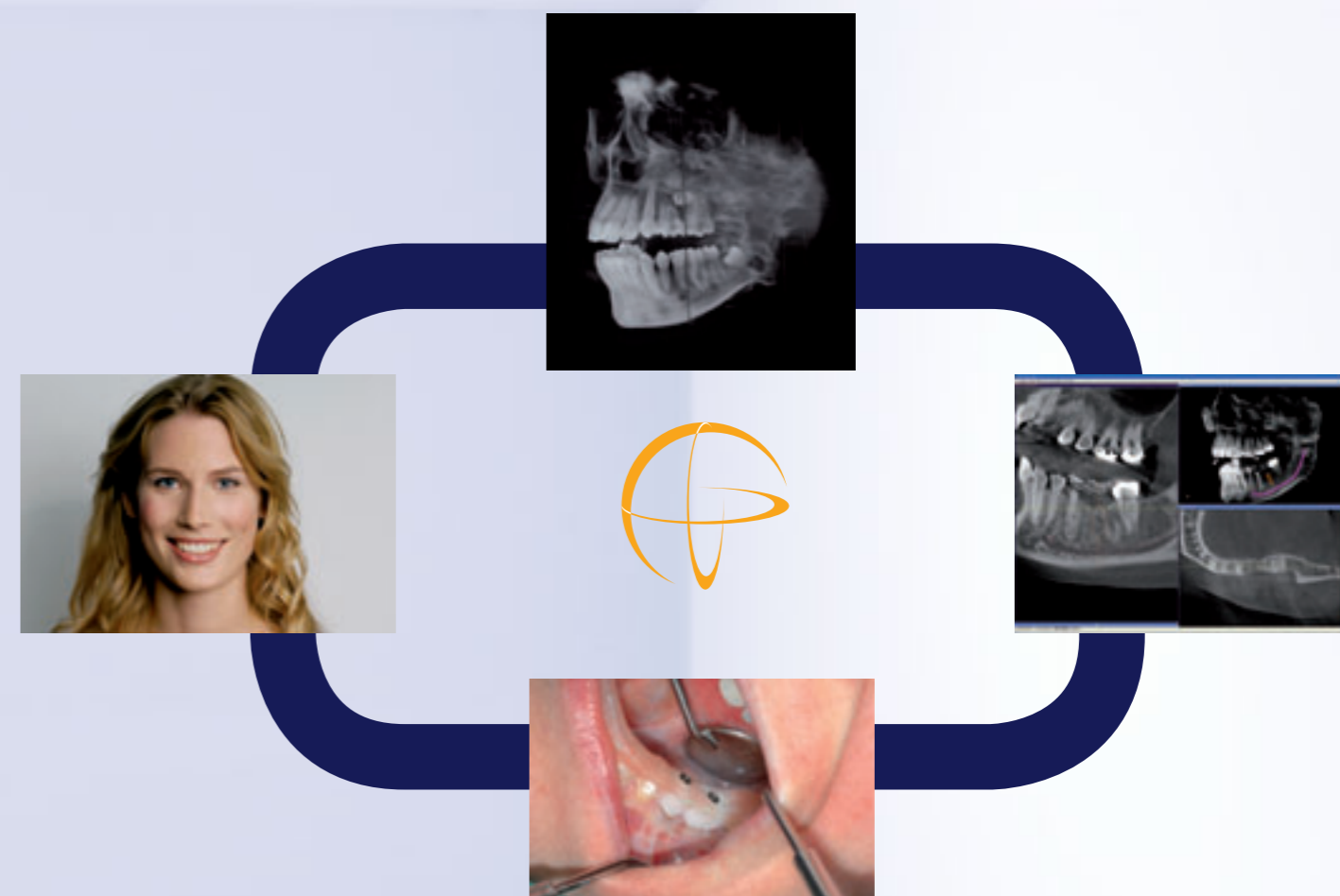

*The traditional process of diagnostics and implant planning consists of many steps often outside of the treating doctor's control. Now, with Sirona 3D it is integrated and streamlined, to the advantage of both patient and dentist.*

GALILEOS is much more than a 3D imaging device or system. Rather, it offers dentists the option of a comprehensive implantology solution using integrated planning and tooth mounted surgical guides.

Thanks to the unique GALILEOS surgical guide technology, all virtual computer-based implant plans are a perfect match for the patient: transgingival, quick, and without trauma.



### Perfect diagnosis

The findings are displayed in optimal 3D image quality and reduce diagnostic uncertainty<sup>8</sup>. The first step toward successful treatment is based, as before, on the superior GALILEOS image acquisition, processing and display capabilities.

### Perfect planning

Based on the display of the bone structures and the prosthetic requirements in three dimensions, the GALILEOS implant system allows the practitioner to select realistic virtual implants from any of the major implant companies and place them in their exact location. This makes it easy to generate a treatment plan that provides confidence to meet with the patient and gain their acceptance within a very short time. Additionally, the GALILEOS Implant planning software is so intuitive that it takes very little time to master.

### Perfect processing

The planning data, the occlusal images and the dental cast of the jaw are sent to siCAT, a Sirona company. The dental office typically receives an individually manufactured surgical guide within 2 weeks. Assuming that the patient has sufficient bone structure, utilizing immediate load implants and CEREC in the dental practice, the entire treatment can be completed in a very short timeframe.

### Perfect implementation

Completely customized results. Planning and implementation are coordinated from start to finish. With the GALILEOS surgical guide technology, all virtual plans match exactly to the patient's anatomical structures, using the GALILEOS system from Sirona.



The dentist assesses the situation on the basis of the 3D GALILEOS X-ray image, advises the patient with the aid of the images and the virtual planning visualization and then implements the treatment with a high level of certainty in their plan.

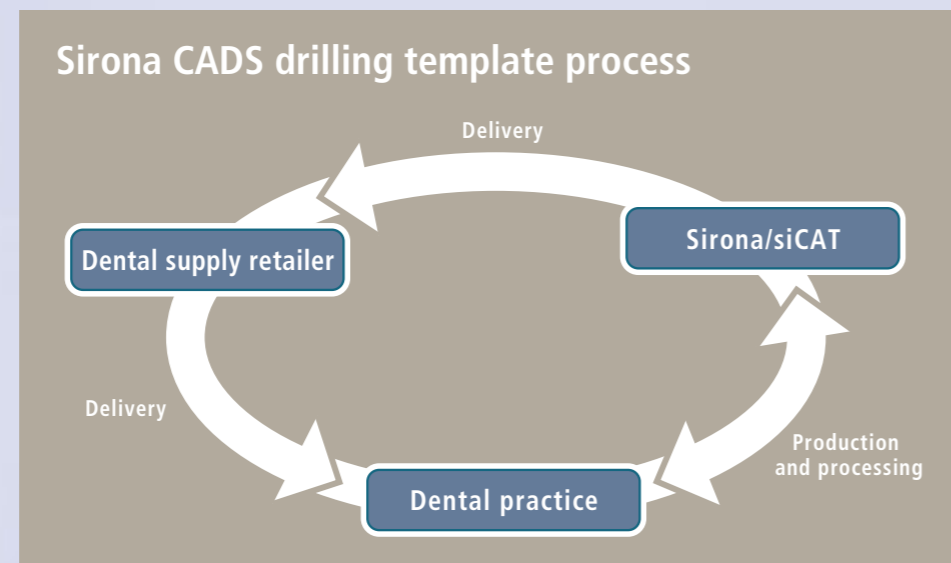

The surgical guide allows for transgingival insertion of the implants, which saves time, reduces uncertainty and assists with less invasive surgery. This creates more confidence for the operating team, which results in less patient discomfort, better recovery and improved osseointegration.

8. Dreiseidler T., Mischkowski R., Neugebauer J., Ritter L., Zöller J.E., Keeve E., "Pre-Surgical Cone Beam Assessment in Dental Implantology" Proceedings of the 8th Congress of the European Association for Cranio-Maxillofacial Surgery, Barcelona, September 2006.

GALILEOS raises diagnostic assessment and documentation to a new level with 3D displays, planning and surgical guides

GALILEOS 



GALILEOS adds a dimension of safety: The surgical guide is the key to every implantology treatment. The entire implant planning process is fully documented from start to finish without any additional effort<sup>9</sup>.

9. Ritter L., Dreiseidler T., Mischkowski R., Neugebauer J., Zöller J.E., Keeve E., "An integrated System for 3D Imaging, Implant Planning and Guided Implant Surgery" 2nd Annual Meeting of the American Academy of Periodontology, San Diego, 16.-19 September, 2006.

## Perfect integration of all systems in a new dimension

The fully integrated solution from Sirona reaches far beyond diagnostics and treatment. Especially in implantology, oral and maxillofacial surgery, absolutely reliable documentation and forensics are essential for every practice.

The integrated workflow of GALILEOS and SIDEXIS XG provides additional value by assisting with the efficient processing of documentation and billing data.

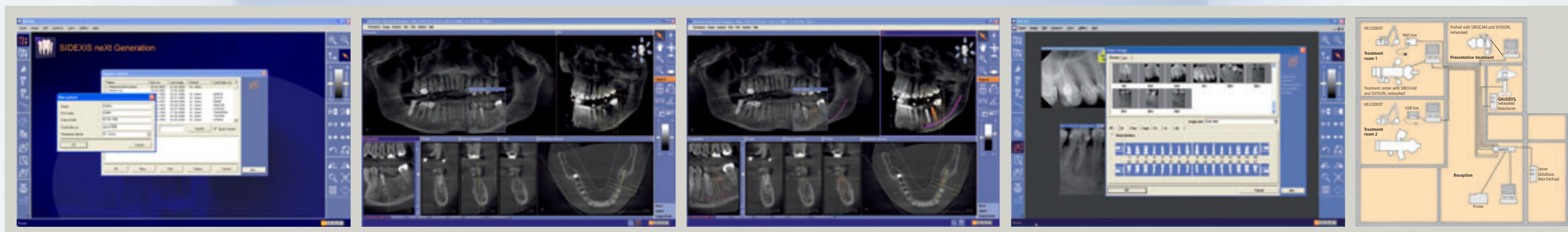

*Patient selection, visualization and image integration, planning and documentation all are part of an integrated workflow that is accessible to all office staff.*

**A new dimension for the dental practice**  
With GALILEOS, "one scan for everything" not only refers to medical needs, but also to all questions of data processing and administration. All essential and pertinent analyses and plans based on the 3D volume are saved as screenshots. From there, they can be used as the direct basis for financial planning with the patient and case acceptance. The GALILEOS software is integrated into SIDEXIS XG, which means it is fully compatible with office management and other special programs. The system also supports DICOM environments.

**Practice integration**  
GALILEOS offers a comprehensive entry into the 3rd dimension with a complete system consisting of 3D X-ray equipment, IT package with reconstruction and control unit (RCU), GALAXIS 3D diagnostic software, and optional GALILEOS Implant software for implant planning. The customized system equipment comes with all required software licenses. It's a simple matter to integrate GALILEOS into the practice network.

### Maximize the benefits in your practice with GALILEOS

#### One scan for everything

- Diagnostically significant findings for all dental indications
- Fast diagnosis provides certainty in treatment of asymptomatic conditions.
- Reduction of follow-up examinations

#### Superior diagnostics

- Higher diagnostic significance for wisdom tooth assessment and removal.
- Improvement of diagnosable X-ray acquisitions compared to 2D technology

#### Integrated Workflow

- Clarification of interfaces with between radiology, prosthodontics and the dentist
- Reduction of data transfer with DICOM-associated problems
- Quick implant planning with software optimized for the workflow

# GALILEOS brings 3D imaging into every practice



With the GALILEOS 3D X-ray solution, virtually every dental practice can get started with 3D imaging without major reconstruction since the entire system was developed with practical application and reliable operation in mind.

### Patient position

With the patient in standing position, GALILEOS provides safe exposures with fascinating efficiency and speed. The system also allows for exposures taken while the patient is seated. The scan only takes 14 seconds, with the patient stabilized by a bite block and a forehead support. The handles provide an additional sense of stability<sup>10</sup>.

10. Ritter L., Dreiseidler T., Neugebauer J., Mischkowski R., Keeve E., Zoeller J., "Influence of the Diagnostic Value of 3D Cone Beam Tomograms" 5th European Congress on Periodontics and Implant Dentistry, Madrid, June 29-30, 2006.

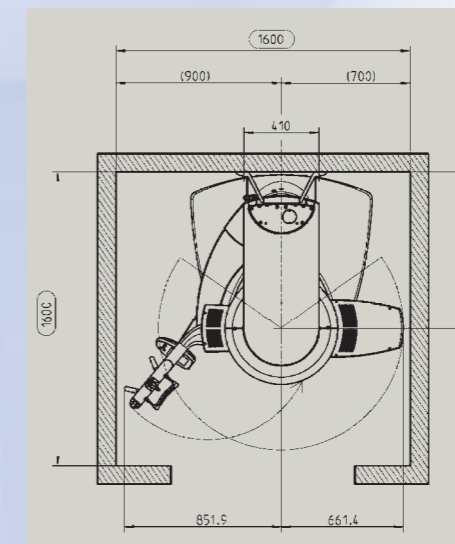

The space requirement for GALILEOS is 6' x 6' x 8.25'.

### Practice integration

The GALILEOS X-ray system requires about the same physical space as most conventional film or digital 2D X-ray devices. Therefore, GALILEOS can be installed in virtually any office with tight space constraints.

### Flexible installation

The GALILEOS X-ray system is usually wall-mounted in the X-ray room. If no solid wall is available, GALILEOS can also be bolted to the floor using a highly stable base.



GALILEOS exposure with patient in standing position.



Patients also have the option of sitting for the exposure if that is their preference.



Remote exposure control is available to mount outside the X-ray room with display of the exposure parameters.

# Superior Sirona 3D X-ray technology for specialized practices



With GALILEOS, Sirona is consistently building on its tradition as a technology leader in imaging systems. The GALILEOS 3D solution includes the X-ray equipment, the IT package with the reconstruction and control unit (RCU), 3D visualization and analysis software, optional 3D implant planning software and, subsequently, optional pre-packaged surgical guide kits.

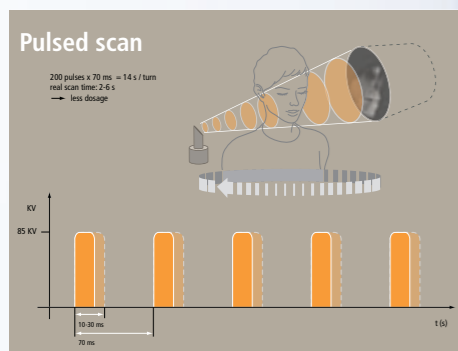

Technological principle of the pulsed scan  
GALILEOS ConeBeam technology

### Perfected technology

GALILEOS is a new 3D X-ray solution which uses ConeBeam technology with a cone-shaped radiation beam. It allows for three-dimensional imaging of the oral-maxillo-facial region, with optimized, distortion-free images recorded by the X-ray detector via the image intensifier. The technology of the image intensifier has been perfected over many years and is currently used in many medical applications.

### Fast 3D imaging volume

The GALILEOS 3D X-ray scan only takes 14 seconds. The GALILEOS reconstruction program calculates the entire image volume from the data of the 200 individual expo-

surements that are generated with a pulsed scan. After seven minutes the image appears in the system for viewing. The pulsating exposure technology keeps the radiation dosage comparatively low.

### Reconstruction with high resolution

The (15x15x15) cm<sup>3</sup> volume is displayed in a resolution of 300 μm. If necessary, selected partial volumes can also be subsequently reconstructed in a higher-contrast resolution of 150 μm – without an additional scan. The close-up function shows a higher level of detail and allows the operator to change to different views.

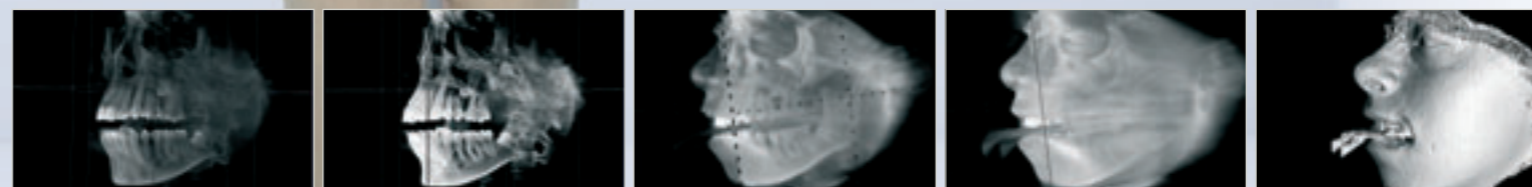

Multiple display options of the 3D volume between bone structure and soft tissue assist with a quick diagnosis of the oral, maxillary and facial region. Proven in more than 2,000 documented cases of maxillofacial surgery of the Cologne University Clinic, the University of North Carolina (UNC Chapel Hill) and other selected dental practices.

### GALILEOS X-ray system at a glance

Exposure volume	(15x15x15) cm <sup>3</sup>
3D resolution Isotropic Voxel size	0.3/0.15 mm
Scan time/Exposure time	14/2-6 s
Reconstruction time	4.5 min
Patient positioning	standing/sitting
X-ray tube assembly kV mA	85 5-7
Effective dose	29 μSv (21 mAs, 85 kV)*
Minimum room dimensions	63" x 63" x 79" (depth x width x height)
Recommended room dimensions	71" x 71" x 99" (depth x width x height)
Radiation protection	Same as with panoramic unit: see DIN 6812: June 2002
Door width	at least 26" for installation
Weight	System approx. 308 lbs.

\* John B. Ludlow, DDS, MS, FDS RCSEd, Department of Diagnostic Sciences and General Dentistry, University of North Carolina School of Dentistry, Chapel Hill, North Carolina, USA.



CAD/CAM SYSTEMS | INSTRUMENTS | HYGIENE SYSTEMS | TREATMENT CENTERS | IMAGING SYSTEMS

**SIRONA – UNIQUE WORLDWIDE SYSTEMS EXPERTISE IN DENTAL EQUIPMENT PRODUCTS**

Sirona develops and manufactures a comprehensive range of dental equipment, including CAD/CAM Systems for dental practices (CEREC) and laboratories (inLab), Instruments and Hygiene Systems, Treatment Centers and Imaging Systems. Sirona manufactures high technology products that guarantee ease of use and a high return on investment – for the good of your practice and for the benefit of your patients. In this way, you can approach every challenge that you face, confident in the knowledge that: **It will be a great day. With Sirona.**

Sirona Dental Systems · E-mail: [contact@sirona.com](mailto:contact@sirona.com) · [www.sirona.com](http://www.sirona.com)

The Dental Company

sirona.